

TILLAGE EQUIPMENT

POCKET IDENTIFICATION GUIDE

Tillage Systems- 

Primary Tillage- 

Secondary Tillage- 

Fertilizer/Manure- 

Combination Tools- 

Other- 



About this guide....

The purpose of the guide is to help you identify commonly used farm equipment. Its color photos and line drawings will help facilitate communication by providing common definitions and RUSLE2 terminology with NRCS and our clients.

Revised Universal Soil Loss Equation, Version 2 (RUSLE2), was developed primarily to guide conservation planning, inventory erosion rates and estimate sediment delivery. Values computed by RUSLE2 are supported by accepted scientific knowledge and technical judgment, are consistent with sound principles of conservation planning, and result in good conservation plans.

The different systems reviewed in this guide are color coded. The page boarder colors will group the different systems together: Tillage Systems-green. Primary Tillage-red. Secondary Tillage-yellow. Fertilizer/Manure-brown. Combination Tools-blue. Other-orange.



MULCH-TILL PLANTING WILL HAVE VARIOUS RESIDUE LEVELS AFTER PLANTING DEPENDING UPON THE NUMBER AND SEVERITY OF TILLAGE PASSES PRIOR TO PLANTING.

MULCH-TILL PLANTING SYSTEM



MULCH-TILL - THE SOIL IS DISTURBED THE FULL WIDTH PRIOR TO PLANTING. TILLAGE TOOLS SUCH AS CHISELS, FIELD CULTIVATORS OR DISKS FULL WIDTH ARE USED. WEED CONTROL IS ACCOMPLISHED WITH HERBICIDES AND/OR CULTIVATION.

MULCH-TILL PLANTING SYSTEM



NO-TILL PLANTING WITH RESIDUE. LONG TERM, NO-TILL IS AN EFFECTIVE EROSION CONTROL AND SIGNIFICANTLY REDUCES SURFACE RUNOFF. THIS REDUCES SEDIMENT AND NUTRIENT LOADING OF LAKES AND STREAMS WHICH IMPROVES WATER QUALITY AND REDUCES FLOODING.

NO-TILL PLANTING SYSTEM



NO-TILL - THE SOIL IS LEFT UNDISTURBED FROM HARVEST TO PLANTING EXCEPT FOR NUTRIENT INJECTION. PLANTING OR DRILLING IS ACCOMPLISHED IN A NARROW SEEDBED OR SLOT CREATED BY COULTERS, ROW CLEANERS OR DISK OPENERS. WEED CONTROL IS ACCOMPLISHED PRIMARILY WITH HERBICIDES. CULTIVATION MAY BE USED FOR EMERGENCY WEED CONTROL.

NO-TILL PLANTING SYSTEM



RIDGE-TILL - THE SOIL IS LEFT UNDISTURBED FROM HARVEST TO PLANTING. PLANTING IS COMPLETED IN A SEEDBED PREPARED ON RIDGES WITH SWEEPS, DISK OPENERS, COULTERS, OR ROW CLEANERS. RESIDUE IS LEFT ON THE SURFACE BETWEEN RIDGES. WEED CONTROL IS ACCOMPLISHED WITH HERBICIDES AND/OR CULTIVATION. RIDGES ARE REBUILT DURING CULTIVATION.

RIDGE-TILL PLANTING SYSTEM



RIDGE-TILL



SEEDBED PREPARATION IS COMPLETED IN A NARROW BAND NO MORE THAN 1/3 OF THE ROW WIDTH. IT MAY BE COMPLETED IN THE FALL WITH THE APPLICATION OF NUTRIENT OR AT PLANTING TIME. CROP RESIDUE AND SOIL CONSOLIDATION IS LEFT UNDISTURBED BETWEEN THE SEEDBED AREAS.

STRIP-TILL AND ZONE TILL PLANTING SYSTEM



STRIP-TILL AND ZONE TILL PLANTING SYSTEM

RUSLE2 - AERATOR, FIELD SURFACE, GROUND DRIVEN



WHILE MAINTAINING SURFACE RESIDUE, SHATTERTINES CRACK AND SHATTER COMPACTED SOIL 8 INCHES TO OPEN NEW CHANNELS FOR AIR AND WATER.

AERWAY



**AERWAY SHATERTINES LIFT
AND FRACTURE THE SOIL TO INCREASE
AIR AND WATER MOVEMENT.**

AERWAY

THE CHISEL PLOW COMPONENTS MAY INCLUDE VARIOUS TYPES OF SWEEPS, SPIKES AND SHOVELS ATTACHED TO THE SHANKS. IN THE MIDWEST, 2-INCH WIDE REVERSIBLE-POINT SPIKES OR 2.5 TO 4-INCH WIDE TWISTED SHOVELS ARE WIDELY USED. SPIKES AND SWEEPS DO LESS SOIL MIXING AND COVER LESS RESIDUE THAN DO TWISTED SHOVELS.

SOME CHISEL PLOWS ARE EQUIPPED WITH A GANG OF COULTERS OR DISK BLADES MOUNTED IN FRONT TO CUT RESIDUE.

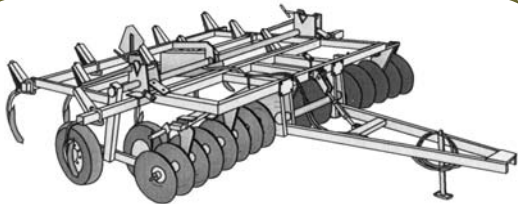

REDUCED TILLAGE IS USUALLY DONE WITH A CHISEL PLOW AND LEAVES 15% TO 30% RESIDUE COVERAGE ON THE SOIL.

CHISEL PLOW



THE SELECTION OF THE SPECIFIC PRIMARY TILLAGE TOOL AND TYPE OF POINTS OR BLADES ARE IMPORTANT TO THE SUCCESS OF MULCH-TILL SYSTEMS. GENERALLY THE LESS INVERSION ACTION THE POINT OR SHOVEL CREATES, THE LESS RESIDUE IS BURIED.

CHISEL PLOW

RUSLE2 - CHISEL, STRAIGHT POINTS

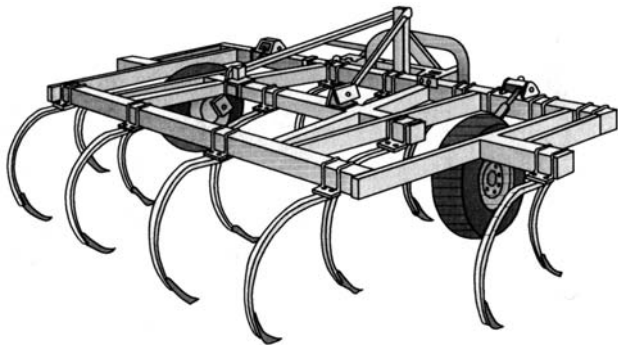

PRIMARY TILLAGE IMPLEMENT DONE IN THE FALL THAT BREAKS AND SHATTERS THE SOIL LEAVING IT ROUGH WITH RESIDUE ON OR NEAR THE SURFACE. OPERATING DEPTH RANGES FROM 6 TO 12 INCHES.

CHISEL PLOW

RUSLE2 - CHISEL, SWEEP SHOVEL



CHISEL WITH SWEEPS



A



B



C



D

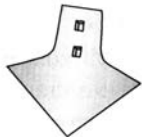

E

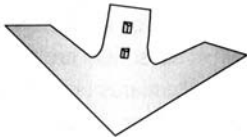

F

A. 2" REVERSIBLE
SPIKE POINT

B. 2" REVERSIBLE
STRAIGHT CHISEL
POINT

C. 3" RIGHT AND LEFT
TWISTED SHOVELS
POINTS

D. 4-1/2" REVERSIBLE
SHOVEL

E. 8" OR 10" SHOVELS

F. 12", 14", 16", OR
18" SWEEPS

CHISEL POINTS

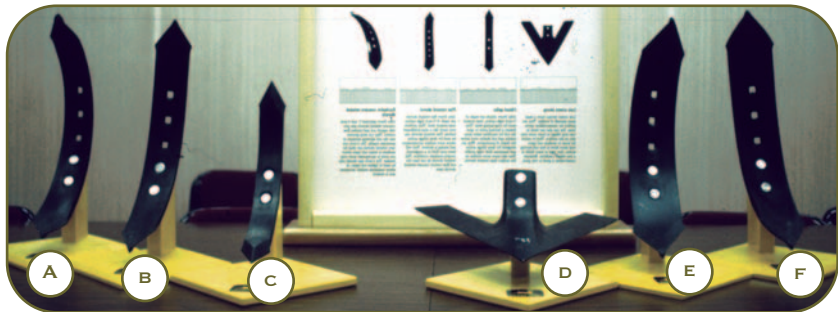

SWEEPS AND SPIKE POINTS BURY LESS RESIDUE THAN DO STRAIGHT POINTS OR TWISTED POINTS. SLOWER SPEEDS AND SHALLOWER OPERATING DEPTHS USUALLY LEAVE MORE RESIDUES.

(A) 3 INCH TWISTED, (B) 3 INCH STRAIGHT, (C) 2 INCH WIDE STRAIGHT, (D) SWEEP, (E) 4 1/2 INCH WIDE TWISTED, (F) 4 1/2 INCH STRAIGHT POINT.

RUSLE2 - DISK, OFFSET

RUSLE2 - DISK TANDEM



OFFSET DISK
IS USED FOR PRIMARY
TILLAGE.

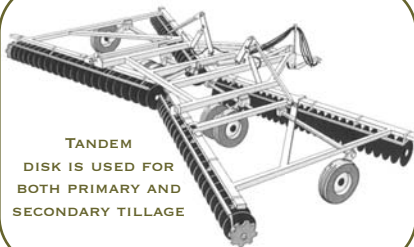

TANDEM
DISK IS USED FOR
BOTH PRIMARY AND
SECONDARY TILLAGE

A DISK IS A TILLAGE IMPLEMENT THAT PULVERIZES OR SMOOTHS THE SOIL. ITS CONCAVE CUTTING BLADES ARE MOUNTED ON A COMMON SHAFT TO FORM A GANG. A DISK CONSISTS OF TWO OR MORE GANGS ATTACHED TO A FRAME. THE OPERATING DEPTH IS USUALLY ONE QUARTER THE DISK DIAMETER.

RUSLE3 - DISK, TANDEM



DISK, TANDEM

RUSLE2 - DISK, OFFSET, HEAVY 15 INCH DEPTH



SOMETIMES CALLED A PLOWING DISK, THIS DISK USES ITS WEIGHT AND LARGE DIAMETER BLADES TO SLICE AND TURN SOIL AND RESIDUE. IT DOES EXTENSIVE SOIL DISTURBANCE AND RESIDUE BURIAL.

HEAVY OFFSET DISK

RUSLE2 - DISK, TANDEM LIGHT FINISH



THE TANDEM LIGHT FINISH TOOL PROVIDES LESS SOIL DISTURBANCE THAN THE OFFSET DISK LEAVING MORE RESIDUE ON THE SOIL SURFACE. THE AMOUNT OF RESIDUE LEFT ON THE SOIL SURFACE DEPENDS UPON THE DEPTH OF TILLAGE, SPEED AND MOISTURE CONTENT OF THE SOIL AT THE TIME OF TILLAGE.

DISK - TANDEM LIGHT FINISH

RUSLE2 - PARA-PLOW OR PARA-TILL

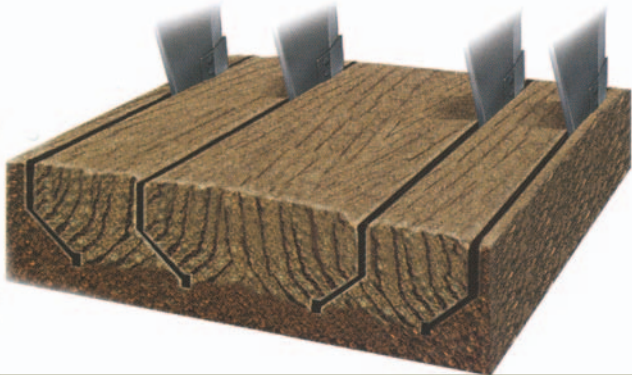

THE PURPOSE OF THE PARA-PLOW IS TO LOOSEN COMPACTED SOIL LAYERS 12 TO 16 INCHES DEEP AND STILL MAINTAIN HIGH SURFACE RESIDUE LEVELS, THE PARA-PLOW LIFTS AND FRACTURES THE SOIL.

PARA-PLOW



**SURFACE RESIDUE IS LEFT ON
THE SOIL SURFACE AS THE SOIL IS
LIFTED AND FRACTURED BELOW.**



PARA-PLOW

RUSLE2 - PLOW, MOLDBOARD



MOLDBOARD PLOW DOES EXTREME LIFTING AND INVERTING THE SOIL LEAVING VERY LITTLE RESIDUE ON THE SOIL SURFACE.

PLOW - MOLDBOARD



PLOW - MOLDBOARD

RUSLE2 - SUBSOILER

THE SUBSOILER IS A PRIMARY TILLAGE TOOL, DONE IN THE FALL, THAT IS SIMILAR TO A CHISEL PLOW. IT IS TYPICALLY DESIGNED TO OPERATE 12 TO 22 INCHES DEEP TO ALLEVIATE SOIL COMPACTION. SUBSOILING IS OFTEN USED TO TRY TO LOOSEN COMPACTED AREAS OF FIELDS WHERE HEAVY LOADS HAVE PASSED. THE AMOUNT OF DISTURBANCE WILL DEPEND UPON THE SHAPE OF THE SHANK AND THE WORKING ANGLE OF THE TOOL BAR.

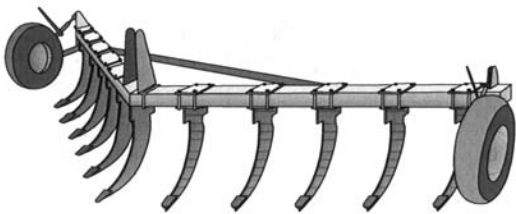

V-RIPPER

IN ROW SUBSOILERS DO LESS SOIL DISTURBANCE THAN A CONVENTIONAL SUBSOILER OR V-RIPPER. USE “SUBSOILER, IN-ROW” FOR THE RUSLE2 OPERATION WHEN USING SUBSOILERS THAT DO LITTLE DISTURBANCE OF SURFACE RESIDUE.

SUBSOILER/V-RIPPER

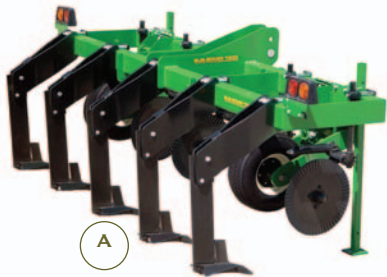

A

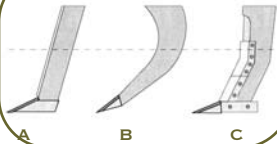

A

B

C

**SUBSOILER
SHANKS: (A) STRAIGHT,
(B) PARABOLIC, AND
(C) BENT LEG.**



B

SUBSOILER/SHANKS

**RUSLE2 - CULTIVATOR, FIELD W/ 6-12 INCH SHOVEL C
& SPIKED TOOTH HARROW ATTACHMENT**



A FIELD CULTIVATOR IS DESIGNED FOR LIGHT TILLAGE AND FIELD FINISHING. USUALLY THEY ARE USED FOR SECONDARY TILLAGE AND FOR INCORPORATING HERBICIDES. SPIKED POINTS FIELD CULTIVATORS DO LITTLE SOIL MIXING AND LEAVE MORE RESIDUE ON THE SURFACE.

FOR RUSLE 2 CALCULATIONS THIS IS TWO OPERATIONS--CULTIVATOR, FIELD WITH 6-12 INCH SHOVELS AND SPIKED TOOTH HARROW.

FIELD CULTIVATOR W/ HARROW ATTACHMENT



FIELD CULTIVATOR--W/ COILED TINE HARROW ATTACHMENT

RUSLE2 - CULTIVATOR, FIELD 6-12 INCH SWEEPS



FIELD CULTIVATORS, EQUIPPED WITH SWEEPS, DO EXTENSIVE HORIZONTAL AND VERTICAL SOIL MIXING. SWEEPS ARE THE CHOICE FOR HERBICIDE INCORPORATION. SWEEPS BURY MORE RESIDUE THAN SPIKED POINT EQUIPPED FIELD CULTIVATORS.

FIELD CULTIVATOR - SWEEPS

**RUSLE 2 - CULTIVATOR, FIELD 6-12 INCH SWEEPS WITH
HARROW COILED TINE**



**FOR RUSLE 2 CALCULATIONS, THIS IS TWO OPERATIONS--
CULTIVATOR, FIELD 6-12 INCH SWEEPS WITH HARROW COILED TINES.**

RUSLE2 - CULTIVATOR, ROTARY

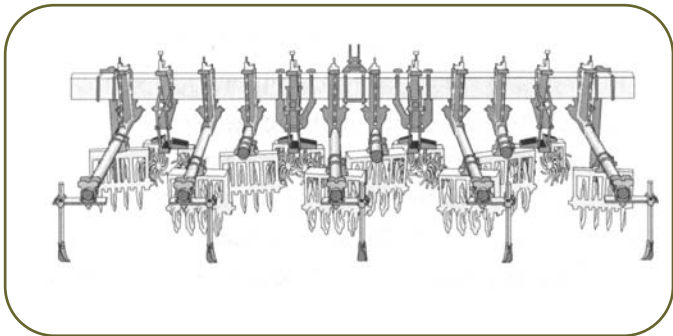

ROLLING CULTIVATOR USES TWO SPIDER GANGS ON EACH ROW ASSEMBLY. IT OPERATES IN HEAVY RESIDUE WITHOUT CLOGGING.

ROLLING CULTIVATOR

RUSLE2 - ROLLING BASKET INCORPORATE



ROLLING CULTIVATOR

RUSLE2 - CULTIVATOR, ROW



ROW CULTIVATORS KILL THE WEEDS WHILE PRESERVING THE CROP.

ROW CULTIVATOR

RUSLE2 - CULTIVATOR, ROW, HIGH RESIDUE



ROW CULTIVATOR

RUSLE2 - HARROW, COILED TINE

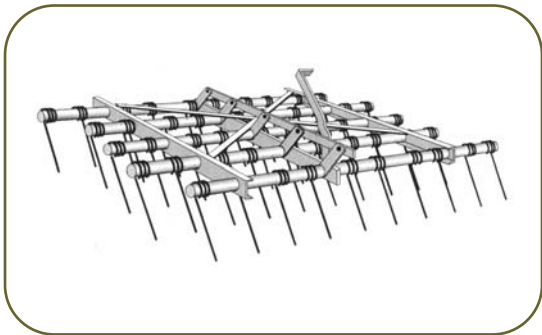

HARROWS ARE PRIMARILY USED TO LEVEL THE SOIL SURFACE, REDISTRIBUTE SURFACE RESIDUE, PULVERIZE CLODS AND DISTURB GERMINATION OF WEEDS. HARROWS ARE OFTEN ATTACHED TO THE REAR OF DISKS, FIELD CULTIVATORS, OR DRILLS TO SMOOTH AND FIRM THE SOIL SURFACE AND REDISTRIBUTE RESIDUE.

HARROWS



**COILED TINE
HARROW**

**PASTURE HARROW
USED TO DISTRIBUTE
MANURE**



**SPIKED
TOOTH HARROW**



HARROWS

RUSLE2 - HARROW, ROTARY

(*OR HARROW ROTARY LIGHT FLUFF FRAGILE)



THE PHILLIPS ROTARY HARROW WORKS IN THE TOP INCH OR SO TO WORK UP SEEDBEDS. IT REDISTRIBUTES RESIDUE AND LEVELS THE GROUND.

(*DEPENDING UPON THE TYPE OF RESIDUE PRESENT, USE HARROW ROTARY FOR HEAVY, NONFRAGILE RESIDUE SUCH AS CORN AND HARROW LIGHT FLUFF FRAGILE FOR LIGHT RESIDUE SUCH AS SOYBEANS.)

HARROW/PHILLIPS

RUSLE2 - HARROW, ROTARY

(*OR HARROW ROTARY LIGHT FLUFF FRAGILE)



TINES DISTURB ONLY THE TOP INCH OR SO OF SOIL. IN GENERAL, THE GREATER A TOOL IS ANGLED OFF OF THE TOOL BAR THE MORE THAT OPERATION WILL DISTURB THE SOIL. THE PHILLIPS HARROW IS PERMANENTLY SET AT A 45 DEGREE ANGLE. (DEPENDING ON THE TYPE OF RESIDUE PRESENT, USE HARROW ROTARY FOR HEAVY, NONFRAGILE RESIDUE SUCH AS CORN AND HARROW LIGHT FLUFF FRAGILE FOR LIGHT RESIDUE SUCH AS SOYBEANS.)

HARROW/PHILLIPS

RUSLE2 - HARROW, ROTARY

(*OR HARROW ROTARY LIGHT FLUFF FRAGILE)



THE PHOENIX HARROW IS A HIGH RESIDUE TILLAGE TOOL THAT DISTURBS THE SOIL ONE-HALF TO TWO INCHES DEEP LEAVING MOST OF THE RESIDUE ON THE SOIL SURFACE. THE GREATER THE HARROW IS ANGLED OFF OF THE TOOL BAR THE MORE THE OPERATION WILL DISTURB THE SOIL.

HARROW/PHOENIX



THE PHOENIX HARROW IS USED TO MIX THE TOP INCH OF SOIL SURFACE TO INCORPORATE HERBICIDES AND LEVEL THE GROUND. THE ANGLE MAY BE ADJUSTED FROM 20 TO 45 DEGREES.



HARROW/PHOENIX

RUSLE2 - ROTARY HOE

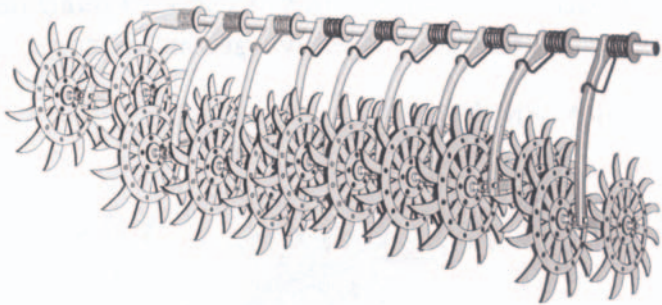

A ROTARY HOE CONSISTS OF ONE OR TWO STAGGERED GANGS OF SPIDER LIKE WHEELS ABOUT 3.5 TO 4 INCHES APART. IT IS A FAST, ECONOMICAL WAY TO CONTROL SMALL WEEDS AND BREAK SURFACE CRUST TO IMPROVE CROP EMERGENCE.

ROTARY HOE



ROTARY HOE



FERTILIZER APPLICATION - ANHYDROUS

RUSLE2 - FERTILIZER APPLICATION, ANHYDROUS KNIFE 30 IN.



IN THE MIDWEST ANHYDROUS AMMONIA SUPPLIES THE MAJORITY OF COMMERCIAL NITROGEN APPLICATION. ANHYDROUS AMMONIA MUST BE INJECTED INTO THE SOIL. THIS IS COMMONLY DONE WITH NARROW KNIVES ATTACHED TO A TOOL BAR PULLED BY A TRACTOR. PRECISE APPLICATION IS IMPORTANT FROM ECONOMIC AND ENVIRONMENTAL PERSPECTIVES.

FERTILIZER APPLICATION - ANHYDROUS AMMONIA

RUSLE2 - FERTILIZER APPLICATION - STRIP TILL



STRIP TILLAGE COMBINES THE BENEFITS OF NO-TILL AND FULL-WIDTH TILLAGE, BUT TILLAGE IS CONFINED TO 6- TO 8-IN. STRIPS INTO WHICH DRY FERTILIZER AND/OR ANHYDROUS AMMONIA CAN BE PLACED. LOOSENED SOIL IN THE STRIPS CREATES A RIDGE OR BERM 3 TO 4 IN. HIGH, WHICH SETTLES DOWN TO 1 TO 2 IN. BY SPRING PLANTING. CROP RESIDUE IN ROW MIDDLES IS LEFT UNDISTURBED.

FERTILIZER APPLICATION - STRIP-TILL

RUSLE2 - FERT. APPLIC., STRIP-TILL 30 IN



RUSLE2 -

WHEN STRIP-TILL OPERATION IS DONE AT PLANTING TIME WITH NO PREVIOUS TILLAGE OPERATION USE "PLANTER, STRIP-TILL."

WHEN STRIP-TILL IS CREATED IN THE FALL OR SPRING PRIOR TO PLANTING OPERATION USE "FERT. APPLIC., STRIP-TILL 30 IN."

BANDING DRY FERTILIZER APPLICATOR

RUSLE2 - MANURE INJECTOR, LIQUID HIGH DISTURB 30 INCH



USING AN UMBILICAL CORD MANURE INJECTION SYSTEM ON 30 INCH SPACING IN BEAN STUBBLE LEAVES LITTLE RESIDUE LEFT ON SOIL SURFACE.

MANURE INJECTOR - HIGH DISTURBANCE



TANK TYPE LIQUID MANURE INJECTOR WITH HIGH DISTURBANCE

MANURE INJECTOR - HIGH DISTURBANCE

RUSLE2 - MANURE INJECTOR, LIQUID LOW DISTURB 15 INCH



TANK TYPE LIQUID MANURE INJECTOR, LOW DISTURBANCE, BUT BECAUSE OF THE 15 INCH ROWS, WILL DISTURB TWICE AS MUCH SOIL SURFACE AS 30 INCH ROWS.

MANURE INJECTOR - LOW DISTURBANCE

RUSLE2 - MANURE INJECTOR, LIQUID LOW DISTURB 15 INCH



PICTURED ABOVE IS A DIS-ASSEMBLED MANURE DISTRIBUTION BOX WHICH USES HIGH SPEED ROTATING KNIVES TO CUT MANURE CHUNKS INTO A NON CLOGGING SIZE. TO THE RIGHT IS A CLOSE UP OF THE DISKS AND INJECTION BLADES.



MANURE INJECTOR - LOW DISTURBANCE

RUSLE2 - COULTER CADDY, 2X W/ COILED TINE HARROW

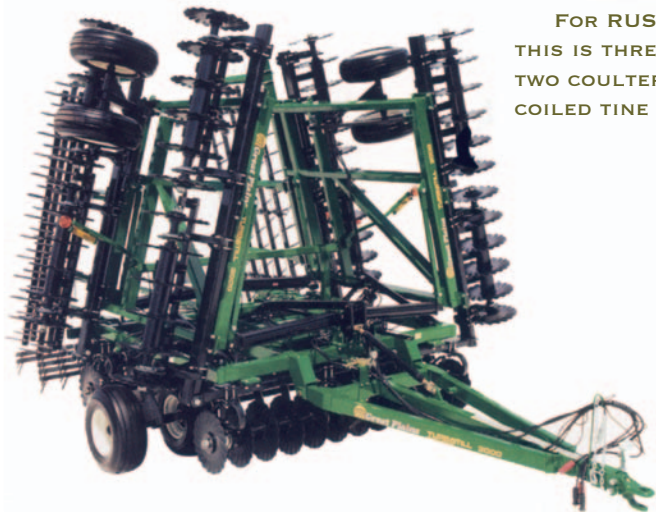

FOR RUSLE2 CALCULATIONS
THIS IS THREE OPERATIONS -
TWO COULTER CADDIES AND ONE
COILED TINE HARROW.

COMBINATION TOOLS

TURBO - TILL

**RUSLE2 - DISK LIGHT FINISH WITH ROLLING
BASKET INCORPORATE**



**FOR RUSLE2 CALCULATIONS THIS IS TWO OPERATIONS - DISK
LIGHT FINISH AND A ROLLING CULTIVATOR**

COMBINATION TOOLS

TURBO - TILL

RUSLE2 - COULTER CADDY W/ HARROW, ROTARY 2X



FOR RUSLE2 CALCULATIONS THIS TILLAGE TOOL IS THREE OPERATIONS--ONE COULTER CADDY AND TWO PHILLIPS HARROWS.

COMBINATION TOOLS

ULTRA - TILL

RUSLE2 - COULTER CADDY W/ HARROW, ROTARY 2X



COMBINATION TOOLS

ULTRA - TILL

**RUSLE2 - COULTER CADDY W/ SUBSOILER AND
ROLLING BASKET INCORPORATE**



VERTI-TILL IS A COULTER/SUBSOILER DESIGNED TO CUT AND SIZE RESIDUE, AS WELL AS DEEP RIP HORIZONTAL DENSITY LAYERS IN ONE PASS. FOR RUSLE2 CALCULATIONS THIS IS THREE OPERATIONS, COULTER CADDY WITH SUBSOILER AND ROLLING CULTIVATOR.

COMBINATION TOOLS

VERTI-TILL

**RUSLE2 - FIELD CULTIVATOR W/ COILED TINE
HARROW ATTACHMENT**



FOR RUSLE2 CALCULATIONS THIS IS TWO OPERATIONS - FIELD CULTIVATOR WITH COILED TINE HARROW.

COMBINATION TOOL

LANDOLL

RUSLE 2 - COULTER CADDY WITH FLUTED COULTERS

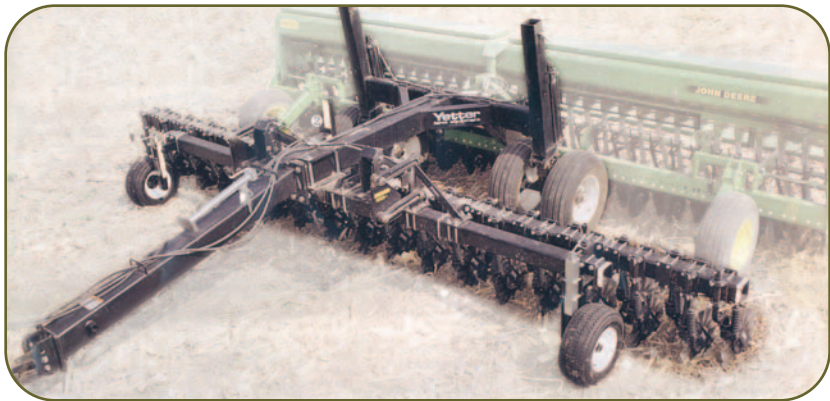

COULTER CADDIES ARE INSTALLED IN FRONT OF GRAIN DRILLS AND OTHER PLANTING EQUIPMENT TO FACILITATE PLANTING UNDER HIGH RESIDUE CONDITIONS.

COULTER CADDY



COULTER CADDY

RUSLE2 - CULTIPACKER, ROLLER



THE CULTIPACKER FIRMS THE SEED BED. THIS CONTRIBUTES TO BETTER SEED SOIL CONTACT AND IS IMPORTANT FOR ESTABLISHMENT OF SMALL SEEDED CROPS LIKE FORAGES.

CULTIPACKER



CULTIPACKER ROLLING

RUSLE2 - DRILL, SINGLE DISK OPENERS, 7-10 IN SPACING



**CONVENTIONAL GRAIN DRILLS DELIVER ACCURATE SEED
METERING AND PLACEMENT WITH OPTIMUM SOIL-TO-SEED CONTACT.**

GRAIN DRILLS



SPECIALTY DRILLS
PROVIDE EXCEPTIONAL
SEED PLACEMENT AND
ACCURATE SEEDING OF
EVERYTHING FROM VERY
SMALL, LIGHT SEEDS TO
DIFFICULT TO HANDLE
SEED SUCH AS NATIVE
GRASS SEEDS.

GRASS DRILLS

RUSLE2 - RESIDUE, ROW CLEANER

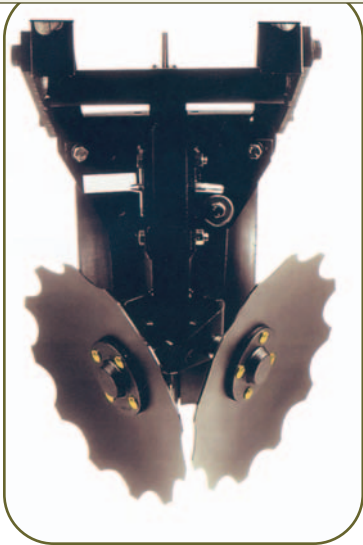

**RESIDUE ROW CLEANERS
ARE USED TO MOVE CROP RESIDUE
AWAY FROM SEEDBED TO FACILITATE
THE PLANTING PROCESS.**

RESIDUE ROW CLEANER

RUSLE2 - RESIDUE, ROW CLEANER



RESIDUE ROW CLEANER

BUBBLE COULTER

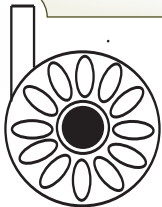

BUBBLE COULTERS TILL A NARROW 0.5 TO 0.75 INCH SLOT AND DO NOT TILL AS MUCH OF THE SEED SLOT. PLANTING DEPTHS ARE MORE RESTRICTED THAN WITH THE FLUTED COULTERS.



DISKS, COULTERS & POINTS

FLUTED COULTER



THE 1 TO 1.5 INCH NARROW FLUTED COULTERS TILL A SLOT WIDE ENOUGH TO ALLOW DOUBLE DISK OPENERS TO PLACE THE SEED AT OPTIMUM DEPTHS. THIS WIDER SLOT PERMITS DEEPER PLACEMENT OF THE SEED.



RIPPLE COULTER

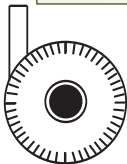

RIPPLED COULTERS TILL A NARROW 0.5 TO 0.75 INCH SLOT AND DO NOT TILL AS MUCH OF THE SEED SLOT. PLANTING DEPTHS ARE MORE RESTRICTED THAN WITH THE FLUTED COULTERS.



CONCAVE DISK

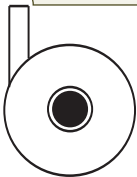

DEPENDING UPON THE SIZE AND DEPTH OF TILLAGE THE CONCAVE DISK DOES FULL WIDTH TILLAGE AND INVERSION OF SOIL. IT IS USED AS A COMPACTION TOOL.



DISKS, COULTERS & POINTS

NOTCHED DISK



NOTCHED DISKS ARE VERY SIMILAR TO THE CONCAVE DISK AND DEPENDS UPON THE SIZE AND DEPTH OF TILLAGE AS TO HOW MUCH SOIL DISTURBANCE IS DONE.



DISKS, COULTERS & POINTS

STRAIGHT DISK

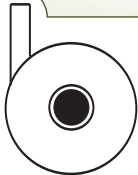

STRAIGHT DISKS ARE USED TO CUT THE SURFACE RESIDUE AND DOES LITTLE INVERSION OF THE SOIL.



DISKS, COULTERS & POINTS

SINGLE DISK OPENERS



SINGLE DISK OPENERS ARE USED TO CUT THE SURFACE RESIDUE.



DISKS, COULTERS & POINTS

DOUBLE DISK OPENERS

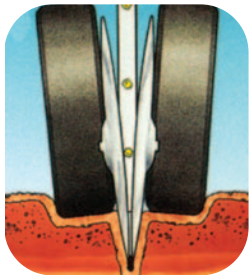

DOUBLE DISK OPENERS ARE TYPICALLY USED IN NO-TILL OR HIGH RESIDUE SYSTEMS. THEY ARE MOUNTED PARALLEL AND EQUIDISTANT TO EACH OTHER AND FORM A "V" SHAPED SLOT IN TO WHICH THE SEED IS DROPPED AS THE PLANTER MOVES ALONG.



DISKS, COULTERS & POINTS

RUSLE2 - Revised Universal Soil Loss Equation is an erosion predictor tool used to estimate average annual soil loss from sheet and rill erosion for a specific site.

The RUSLE2 crop year starts with the “harvest” of the previous crop and includes all of the operations that are completed to prepare seedbed, plant, weed control up to and including harvest. In the example below the first crop to be planted is corn followed by all of the operations. The second crop to be planted is soybeans and includes all of the tillage operations since harvest of the corn crop.

Example: corn grain; Sfcult, soybean; wr, FC st pt, disk, fcult

The above example is a Corn Soybean rotation in which corn is planted into soybean stubble that has been spring field cultivated prior to planting; soybeans are planted wide row (30 inch rows) into corn stalks that have been fall chiseled with straight points, disked and field cultivated prior to planting.

Many tillage tools are combinations of operations described in RUSLE2. These tools can be accounted for in RUSLE2 calculations by combining two or more operations on the same day to fully describe the overall tool being used.

RUSLE2 Glossary of Abbreviations

3X - 3 years of growth included

FC st pt - Fall chiseled with straight points

FC sweep - Fall Chiseled with sweeps

FC Twist - Fall Chiseled with twisted points

Fdisk - Fall disk

Ffcult - Fall field cultivate

FP - Fall Plow

NR or nr - narrow row

NT - No-till

NT anhyd - No-till with anhydrous application

RT - Ridge till

SC st pt - Spring Chiseled with straight points

RUSLE2 Glossary of Abbreviations Continued

SC sweep - Spring Chiseled with sweeps

SC Twist - Spring Chiseled with twisted points

Sdisk - Spring disk

Sfcult - Spring field cultivate

SP - Spring Plow

ST - Strip till

eh - early harvest

ep - early plant

lh - late harvest

lp - late planting date

mp - middle planting date

wr - wide row (> 30 inches)

z4 - crop management zone 4

z16 - crop management zone 16



The U.S. Department of Agriculture (USDA) prohibits discrimination in all its programs and activities on the basis of race, color, national origin, sex, religion, age, disability, political beliefs, sexual orientation, or marital or family status. (Not all prohibited bases apply to all programs.) Persons with disabilities who require alternative means for communication of program into formation (Braille, large print, audiotape, etc.) should contact USDA's TARGET Center at 202-720-2600 (voice and TDD).

To file a complaint of discrimination, write USDA, Director, Office of Civil Rights, Room 326W, Whitten Building, 14th and Independence Avenue SW, Washington, DC 20250-9410 or call (202) 720-5964 (voice and TDD). USDA is an equal opportunity provider and employer.